



Product Catalogue 2018
LOCKING PLATES

FDA
510K
CLEARED

CE
1023



INDEX



Description	Page No.	Description	Page No.	Description	Page No.
Locking Plate Clavicle Hook 3.5mm, Right/Left	1	Locking Distal Dorsal Radius T-Plate 2.7mm	10	Locking Plate Tibia Distal Lateral 4.5/5.0mm, Right/Left	20
Locking Plate Superior Anterior Clavicle 2.7/ 3.5mm	1	Locking Distal Dorsal Radius L-Plate 2.7mm, Right/Left	10	Locking Plate Anatomical Distal Tibia 3.5mm, Right/Left	21
Locking Plate Superior Anterior Clavicle 3.5mm, Right/Left	1	Locking Distal Dorsal Radius L-Plate 2.7mm Type - II, Right/Left	10	Locking Plate Anatomical Distal Tibia 4.5/5.0mm, Right/Left	21
Locking Clavicle S-Plate 3.5mm, Right/Left	1	Locking Plate Radio Distal Dorsal 3.5mm, Right/Left	11	Locking Plate Pilon 3.5mm	21
Locking Plate Metaphyseal 3.5mm	2	Locking Plate Radio Distal Lateral 3.5mm	11	Locking Plate Fibula Distal Lateral 3.5mm	21
Locking Plate Proximal Humeral 3.5mm, Short	2	Locking Plate Reconstruction 3.5mm	11	Locking Plate Distal Fibula Lateral 2.7/3.5mm, Right/Left	22
Locking Plate Proximal Humeral 3.5mm, Long	2	Locking Plate Reconstruction 4.5mm	11	Locking Plate Posterolateral Distal Fibula Plate 2.7/3.5mm	22
Locking Plate Proximal Humeral 3.5mm Type - I	2	Locking Plate Proximal Femoral Lateral 4.5/5.0mm Type - I,	12	Locking Plate Anatomical Distal Tibia Plate For Fibula 3.5mm	22
Locking Plate Periarticular Proximal Humeral 3.5mm, Right/Left	3	Locking Plate Proximal Femoral Hook 4.5/5.0mm Type - II,	12	Locking Plate Anatomical Distal Tibia Plate For Fibula 4.5/5.0mm	22
Locking Plate Clover Leaf 3.5mm	3	Locking Plate Pediatric Hip 3.5 & 5.0mm	12	Locking Plate Calcaneal 3.5mm, Right/Left	23
Locking Plate Small 3.5mm	3	Locking Plate DHS 135° With Long Barrel 38mm	12	DHS/DCS Lag Screw	23
Locking Plate Curved Narrow 3.5mm	3	Locking Plate DCS 95°	13	Cortical Screw, Dia - 2.4mm - Self Tapping	23
Locking Plate Curved Broad 3.5mm	4	Locking Plate Condylar Butteress 4.5/5.0mm, Right/Left	13	Cortical Screw, Dia - 2.7mm - Self Tapping	23
Locking Hook Plate 3.5mm	4	Locking Plate Narrow 4.5mm/5.0mm	13	Locking Head Screw, Dia - 2.7mm - Self Tapping	24
Locking Plate One - Third Tubular 3.5mm	4	Locking Plate Curved Narrow 4.5mm/5.0mm	13	Cortical Screw, Dia - 3.5mm - Self Tapping	24
Locking Plate Humeral Distal Medial 2.7/3.5mm, Right/Left	4	Locking Plate Broad 4.5mm/5.0mm	14	Cortical Screw, Dia - 4.5mm - Self Tapping	24
Locking Plate Humeral Distal Medial 3.5mm	5	Locking Plate Curved Broad 4.5mm/5.0mm	14	Locking Head Screw, Dia - 3.5mm - Self Tapping	24
Locking Plate Humeral Distal Dorsal Without Support 2.7/3.5mm,	5	Locking Plate Distal Femoral 4.5/5.0mm, Right/Left	14	Locking Head Screw, Dia - 5.0mm - Self Tapping	25
Locking Plate Humeral Distal Dorsal Without Support 3.5mm	5	Locking Plate T-Fix Distal Femoral 4.5/5.0mm, Right/Left	14	Locking Head Cancellous Screw Dia - 5.0mm "16mm Thread"	25
Locking Plate Humeral Distal Dorsal With Support 2.7/3.5mm	5	Locking Plate Periarticular Distal Femur 4.5/5.0mm Right/Left	15	Locking Head Cancellous Screw Dia - 5.0mm "32mm Thread"	25
Locking Plate Humeral Distal Dorsal With Support 3.5mm	6	Locking T-Plate Single Curved 4.5/5.0mm	15	Locking Head Cancellous Screw Dia - 5.0mm "Full Thread"	25
Locking Plate Extra-articular Distal Humerus 3.5mm, Right/Left	6	Locking T-Plate Double Curved 4.5/5.0mm	15	Locking Head Screw, Dia - 6.5mm "16mm Thread"	26
Locking Plate Olecranon 3.5mm Type - I, Right/Left	6	Locking T-Fix T-Plate 4.5/5.0mm	15	Locking Head Cancellous Screw Dia - 6.5mm "32mm Thread"	26
Locking Plate Olecranon 3.5mm Type - II	6	Locking L-Plate Double Curved 4.5/ 5.0mm, Right/Left	16	Locking Head Cancellous Screw Dia - 6.5mm "Full Thread"	26
Locking T-Plate Right Angle 3.5mm	7	Locking Plate Proximal Lateral Tibia 4.5/5.0mm, Right/Left	16	Locking Head Cancellous Screw 3.5 mm "Full Thread"	26
Locking T-Plate Right Angle 3.5mm, 4 Hole Head	7	Locking Plate T-Fix Proximal Tibia 4.5/5.0mm, Right/Left	16	Locking Head Cancellous Screw 3.5 mm "Short Thread"	27
Locking T-Plate Oblique Angled 3.5mm, Right/Left	7	Locking Plate Proximal Tibia 3.5mm, Right/Left	16	Locking Head Cannulated Cancellous Screw	
Locking Distal Volar Radius Anatomic Plates 2.4/2.7mm Right/Left	7	Locking Plate Proximal Lateral Tibia 4.5/5.0mm, Right/Left	17	Dia - 5.0mm "16mm Thread"	27
Locking Plate Volar Column Distal Radius 2.4/2.7mm	8	Locking Plate Medial Proximal Tibia 3.5mm, Right/Left	17	Locking Head Cannulated Cancellous Screw	
8 & 9 Hole Head	8	Locking Proximal Tibia Plate 3.5mm Type - II Low Bend	17	Dia - 5.0mm "32mm Thread"	27
Locking Plate Proximal Radius 2.4/2.7mm	8	Locking Plate Periarticular Proximal Tibia 3.5mm, Right/Left	17	Locking Head Cannulated Cancellous Screw	
Locking Plate Volar Column Distal Radius 2.4/2.7mm	8	Locking Plate Periarticular Proximal Tibia 3.5/5.0mm, Right/Left	18	Dia - 5.0mm "Full Thread"	27
6 Hole Head, Right/Left	8	Locking Posteromedial Proximal Tibia Plate 3.5mm	18	Locking Head Cannulated Cancellous Screw 3.5 mm	
Locking Plate Extra-Articular Volar Distal Radius 2.4/2.7mm	8	Locking Plate Medial Distal Tibia Without Tab 3.5mm, Right/Left	18	"Full Thread"	28
4 Hole Head, Right/Left	8	Locking Plate Medial Proximal Tibia 4.5mm, Right/Left	18	Locking Head Cannulated Cancellous Screw 3.5 mm	
Locking Plate Extra-Articular Volar Distal Radius 2.4/2.7mm	9	Locking Plate Anatomical Proximal Tibia 3.5mm, Right/Left	19	"Short Thread"	28
5 Hole Head Type - I	9	Locking Plate Anatomical Proximal Tibia 4.5/5.0mm, Right/Left	19	Locking Head Cannulated Cancellous Screw	
Locking Plate Extra-Articular Volar Distal Radius 2.4/2.7mm	9	Locking Plate Distal Tibia 2.7/3.5mm, Right/Left	19	Dia - 6.5mm "16mm Thread"	28
5 Hole Head Type - II	9	Locking Plate Distal Tibia 3.5mm, Right/Left	19	Locking Head Cannulated Cancellous Screw	
Locking Plate Extra-Articular Volar Distal Radius 2.4/2.7mm	9	Locking Plate Metaphyseal 3.5/4.5/5.0mm	20	Dia - 6.5mm "32mm Thread"	28
5 Hole Head Type - III	9	Locking Plate Metaphyseal For Distal Medial Tibia 3.5/4.5/5.0mm	20	Locking Head Cannulated Cancellous Screw	
Locking Plate Wrist Fusion	9	Locking Plate Anterolateral Distal Tibia 3.5mm, Right/Left	20	Dia - 6.5mm "Full Thread"	29
Locking Plate Distal Lateral Radius 2.7mm	10			Instrument Sets	29



1. Locking Plate Clavicle Hook 3.5mm, Right/Left



FDA
510K
CLEARED

Ref. No. Ti	Ref. No. SS	Position	Size	Ref. No. Ti	Ref. No. SS	Position	Size
LCP510102	AK-0212R	Right	4H	LCP510202	AK-0212L	Left	4H
LCP510103	AK-0213R	Right	5H	LCP510203	AK-0213L	Left	5H
LCP510105	AK-0215R	Right	6H	LCP510205	AK-0215L	Left	6H
LCP510107	AK-0217R	Right	7H	LCP510207	AK-0217L	Left	7H

Available in 12/15/18mm Hook Depth

3. Locking Plate Superior Anterior Clavicle 3.5mm, Right/Left



Ref. No. Ti	Ref. No. SS	Position	Size	Ref. No. Ti	Ref. No. SS	Position	Size
LCP665106	BA-006R	Right	6H	LCP665206	BA-006L	Left	6H
LCP665107	BA-007R	Right	7H	LCP665207	BA-007L	Left	7H
LCP665108	BA-008R	Right	8H	LCP665208	BA-008L	Left	8H

2. Locking Plate Superior Anterior Clavicle 2.7/ 3.5mm with Lateral Extension, Right/Left

Suitable for Ø 2.7 mm
Locking Screw



Ref. No. Ti	Ref. No. SS	Position	Size	Ref. No. Ti	Ref. No. SS	Position	Size
LCP665303	BC-003R	Right	3H	LCP665403	BC-003L	Left	3H
LCP665304	BC-004R	Right	4H	LCP665404	BC-004L	Left	4H
LCP665305	BC-005R	Right	5H	LCP665405	BC-005L	Left	5H
LCP665306	BC-006R	Right	6H	LCP665406	BC-006L	Left	6H
LCP665307	BC-007R	Right	7H	LCP665407	BC-007L	Left	7H
LCP665308	BC-008R	Right	8H	LCP665408	BC-008L	Left	8H

4. Locking Clavicle S-Plate 3.5mm, Right/Left



Ref. No. Ti	Ref. No. SS	Position	Size	Ref. No. Ti	Ref. No. SS	Position	Size
LCPCSP06R	AL-006R	Right	6H	LCPCSP06L	AL-006L	Left	6H
LCPCSP07R	AL-007R	Right	7H	LCPCSP07L	AL-007L	Left	7H
LCPCSP08R	AL-008R	Right	8H	LCPCSP08L	AL-008L	Left	8H
LCPCSP09R	AL-009R	Right	9H	LCPCSP09L	AL-009L	Left	9H
LCPCSP10R	AL-010R	Right	10H	LCPCSP10L	AL-010L	Left	10H
LCPCSP12R	AL-012R	Right	12H	LCPCSP12L	AL-012L	Left	12H

Specifications, size, shape subject to change without notice.
Picture shape if similar to any other manufacturers is just a co-incident.

5. Locking Plate Metaphyseal 3.5mm



Ref. No. Ti	Ref. No. SS	Size
LCP506006	AD-006	6H
LCP506007	AD-007	7H
LCP506008	AD-008	8H
LCP506009	AD-009	9H
LCP506010	AD-010	10H
LCP506011	AD-011	11H
LCP506012	AD-012	12H

Ref. No. Ti	Ref. No. SS	Size
LCP506013	AD-013	13H
LCP506014	AD-014	14H
LCP506015	AD-015	15H
LCP506016	AD-016	16H
LCP506017	AD-017	17H
LCP506018	AD-018	18H

7. Locking Plate Proximal Humeral 3.5mm, Long



FDA
510K
CLEARED

Ref. No. Ti	Ref. No. SS	Size
LCP509205	GG-005	5H
LCP509206	GG-006	6H
LCP509208	GG-008	8H
LCP509210	GG-010	10H
LCP509212	GG-012	12H

6. Locking Plate Proximal Humeral 3.5mm, Short



FDA
510K
CLEARED

Ref. No. Ti	Ref. No. SS	Size
LCP508003	HH-003	3H
LCP508005	HH-005	5H

8. Locking Plate Proximal Humeral 3.5mm Type - I



FDA
510K
CLEARED

Ref. No. Ti	Ref. No. SS	Size
LCP519205	PH-005	5H
LCP519206	PH-006	6H
LCP519208	PH-008	8H
LCP519209	PH-009	9H
LCP519210	PH-010	10H
LCP519212	PH-012	12H

Specifications, size, shape subject to change without notice.
Picture shape if similar to any other manufacturers is just a co-incident.



9. Locking Plate Periarticular Proximal Humeral 3.5mm, Right/Left



Ref. No. Ti	Ref. No. SS	Position	Size	Ref. No. Ti	Ref. No. SS	Position	Size
LCP681102	PPHP-002R	Right	2H	LCP681202	PPHP-002L	Left	2H
LCP681103	PPHP-003R	Right	3H	LCP681203	PPHP-003L	Left	3H
LCP681104	PPHP-004R	Right	4H	LCP681204	PPHP-004L	Left	4H
LCP681105	PPHP-005R	Right	5H	LCP681205	PPHP-005L	Left	5H
LCP681106	PPHP-006R	Right	6H	LCP681206	PPHP-006L	Left	6H
LCP681108	PPHP-008R	Right	8H	LCP681208	PPHP-008L	Left	8H
LCP681110	PPHP-010R	Right	10H	LCP681210	PPHP-010L	Left	10H
LCP681112	PPHP-012R	Right	12H	LCP681212	PPHP-012L	Left	12H
LCP681114	PPHP-014R	Right	14H	LCP681214	PPHP-014L	Left	14H

11. Locking Plate Small 3.5mm



Ref. No. Ti	Ref. No. SS	Size
LCP501005	AA-005	5H
LCP501006	AA-006	6H
LCP501007	AA-007	7H
LCP501008	AA-008	8H
LCP501009	AA-009	9H
LCP501010	AA-010	10H
LCP501011	AA-011	11H
LCP501012	AA-012	12H



10. Locking Plate Clover Leaf 3.5mm

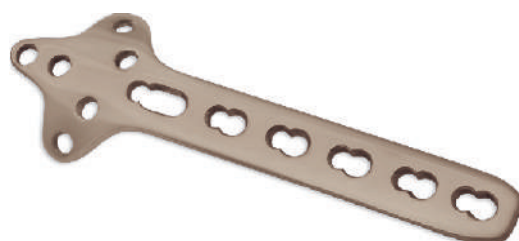

Ref. No. Ti	Ref. No. SS	Size
LCP676903	BD-003	3H
LCP676904	BD-004	4H
LCP676905	BD-005	5H
LCP676906	BD-006	6H
LCP676907	BD-007	7H
LCP676908	BD-008	8H

12. Locking Plate Curved Narrow 3.5mm



Ref. No. Ti	Ref. No. SS	Size
LCP700010	CN-010	10H
LCP700011	CN-011	11H
LCP700012	CN-012	12H
LCP700014	CN-014	14H
LCP700016	CN-016	16H
LCP700018	CN-018	18H
LCP700020	CN-020	20H
LCP700022	CN-022	22H



Specifications, size, shape subject to change without notice.
Picture shape if similar to any other manufacturers is just a co-incident.

13. Locking Plate Curved Broad 3.5mm



Ref. No. Ti	Ref. No. SS	Size
LCP710010	CB-010	10H
LCP710011	CB-011	11H
LCP710012	CB-012	12H
LCP710014	CB-014	14H
LCP710016	CB-016	16H
LCP710018	CB-018	18H

Ref. No. Ti	Ref. No. SS	Size
LCP710020	CB-020	20H
LCP710022	CB-022	22H
LCP710024	CB-024	24H
LCP710026	CB-026	26H
LCP710028	CB-028	28H
LCP710030	CB-030	30H

15. Locking Plate One - Third Tubular 3.5mm



Ref. No. Ti	Ref. No. SS	Size
LCP681002	OT-002	2H
LCP681003	OT-003	3H
LCP681004	OT-004	4H
LCP681005	OT-005	5H
LCP681006	OT-006	6H
LCP681007	OT-007	7H
LCP681008	OT-008	8H
LCP681009	OT-009	9H
LCP681010	OT-010	10H
LCP681012	OT-012	12H

14. Locking Hook Plate 3.5mm



Ref. No. Ti	Ref. No. SS	Size
LCP666503	BJ-003	62mm

16. Locking Plate Humeral Distal Medial 2.7/3.5mm, Right/Left

Suitable for \varnothing 2.7 mm Locking Screw



Ref. No. Ti	Ref. No. SS	Position	Size
LCP513203	AY-003R	Right	3H
LCP513205	AY-005R	Right	5H
LCP513207	AY-007R	Right	7H
LCP513209	AY-009R	Right	9H
LCP513211	AY-011R	Right	11H

Ref. No. Ti	Ref. No. SS	Position	Size
LCP513103	AY-003L	Left	3H
LCP513105	AY-005L	Left	5H
LCP513107	AY-007L	Left	7H
LCP513109	AY-009L	Left	9H
LCP513111	AY-011L	Left	11H

Specifications, size, shape subject to change without notice.
Picture shape if similar to any other manufacturers is just a co-incident.



17. Locking Plate Humeral Distal Medial 3.5mm



Ref. No. Ti	Ref. No. SS	Size
LCP513403	AI-003	3H
LCP513405	AI-005	5H
LCP513407	AI-007	7H
LCP513409	AI-009	9H
LCP513411	AI-011	11H

19. Locking Plate Humeral Distal Dorsal Without Support 3.5mm, Right/Left



Ref. No. Ti	Ref. No. SS	Position	Size	Ref. No. Ti	Ref. No. SS	Position	Size
LCP504703	AM-003R	Right	3H	LCP504803	AM-003L	Left	3H
LCP504705	AM-005R	Right	5H	LCP504805	AM-005L	Left	5H
LCP504707	AM-007R	Right	7H	LCP504807	AM-007L	Left	7H
LCP504709	AM-009R	Right	9H	LCP504809	AM-009L	Left	9H
LCP504711	AM-011R	Right	11H	LCP504811	AM-011L	Left	11H
LCP504714	AM-014R	Right	14H	LCP504814	AM-014L	Left	14H

18. Locking Plate Humeral Distal Dorsal Without Support 2.7/3.5mm, Right/Left

Suitable for \varnothing 2.7 mm Locking Screw



Ref. No. Ti	Ref. No. SS	Position	Size	Ref. No. Ti	Ref. No. SS	Position	Size
LCP504403	AZ-003R	Right	3H	LCP504303	AZ-003L	Left	3H
LCP504405	AZ-005R	Right	5H	LCP504305	AZ-005L	Left	5H
LCP504407	AZ-007R	Right	7H	LCP504307	AZ-007L	Left	7H
LCP504409	AZ-009R	Right	9H	LCP504309	AZ-009L	Left	9H
LCP504411	AZ-011R	Right	11H	LCP504311	AZ-011L	Left	11H
LCP504414	AZ-014R	Right	14H	LCP504314	AZ-014L	Left	14H

20. Locking Plate Humeral Distal Dorsal With Support 2.7/3.5mm, Right/Left



Ref. No. Ti	Ref. No. SS	Position	Size	Ref. No. Ti	Ref. No. SS	Position	Size
LCP504503	AK-003R	Right	3H	LCP504603	AK-003L	Left	3H
LCP504505	AK-005R	Right	5H	LCP504605	AK-005L	Left	5H
LCP504507	AK-007R	Right	7H	LCP504607	AK-007L	Left	7H
LCP504509	AK-009R	Right	9H	LCP504609	AK-009L	Left	9H
LCP504511	AK-011R	Right	11H	LCP504611	AK-011L	Left	11H
LCP504514	AK-014R	Right	14H	LCP504614	AK-014L	Left	14H

Specifications, size, shape subject to change without notice.
Picture shape if similar to any other manufacturers is just a co-incident.

21. Locking Plate Humeral Distal Dorsal With Support 3.5mm, Right/ Left



Ref. No. Ti	Position	Size
LCP504103	Right	3H
LCP504105	Right	5H
LCP504107	Right	7H
LCP504109	Right	9H
LCP504111	Right	11H
LCP504114	Right	14H

Ref. No. Ti	Position	Size
LCP504203	Left	3H
LCP504205	Left	5H
LCP504207	Left	7H
LCP504209	Left	9H
LCP504211	Left	11H
LCP504214	Left	14H

23. Locking Plate Olecranon 3.5mm Type - I, Right/Left



Ref. No. Ti	Ref. No. SS	Position	Size
LCP666302	BI-002R	Right	2H
LCP666304	BI-004R	Right	4H
LCP666306	BI-006R	Right	6H
LCP666308	BI-008R	Right	8H
LCP666310	BI-010R	Right	10H
LCP666312	BI-012R	Right	12H

Ref. No. Ti	Ref. No. SS	Position	Size
LCP666402	BI-002L	Left	2H
LCP666404	BI-004L	Left	4H
LCP666406	BI-006L	Left	6H
LCP666408	BI-008L	Left	8H
LCP666410	BI-010L	Left	10H
LCP666412	BI-012L	Left	12H

22. Locking Plate Extra-articular Distal Humerus 3.5mm, Right/Left



Ref. No. Ti	Ref. No. SS	Position	Size
LCP666204	BH-004R	Right	4H
LCP666206	BH-006R	Right	6H
LCP666208	BH-008R	Right	8H
LCP666210	BH-010R	Right	10H
LCP666212	BH-012R	Right	12H
LCP666214	BH-014R	Right	14H

Ref. No. Ti	Ref. No. SS	Position	Size
LCP666104	BH-004L	Left	4H
LCP666106	BH-006L	Left	6H
LCP666108	BH-008L	Left	8H
LCP666110	BH-010L	Left	10H
LCP666112	BH-012L	Left	12H
LCP666114	BH-014L	Left	14H

24. Locking Plate Olecranon 3.5mm Type - II



Ref. No. Ti	Ref. No. SS	Size
LCP515003	AH-003	3H
LCP515004	AH-004	4H
LCP515005	AH-005	5H
LCP515006	AH-006	6H
LCP515007	AH-007	7H
LCP515008	AH-008	8H



25. Locking T-Plate Right Angle 3.5mm



Ref. No. Ti	Ref. No. SS	Size
LCP512003	BB-003	3H
LCP512004	BB-004	4H
LCP512005	BB-005	5H
LCP512006	BB-006	6H
LCP512007	BB-007	7H

27. Locking T-Plate Oblique Angle 3.5mm, Right/Left



Ref. No. Ti	Ref. No. SS	Position	Size	Ref. No. Ti	Ref. No. SS	Position	Size
LCP511103	CC-003R	Right	3H	LCP511203	CC-003L	Left	3H
LCP511104	CC-004R	Right	4H	LCP511204	CC-004L	Left	4H
LCP511105	CC-005R	Right	5H	LCP511205	CC-005L	Left	5H

26. Locking T-Plate Right Angle 3.5mm, 4 Hole Head



Ref. No. Ti	Ref. No. SS	Size
LCP514003	LCBB003	3H
LCP514004	LCBB004	4H
LCP514005	LCBB005	5H
LCP514006	LCBB006	6H

28. Locking Distal Volar Radius Anatomic Plates 2.4/2.7mm Right/Left



Ref. No. Ti	Ref. No. SS	Position	Size	Ref. No. Ti	Ref. No. SS	Position	Size
LCP677003	DVRS-003R	Right	3H	LCP677103	DVRS-003L	Left	3H
LCP677004	DVRS-004R	Right	4H	LCP677104	DVRS-004L	Left	4H
LCP677007	DVRS-007R	Right	7H	LCP677107	DVRS-007L	Left	7H
LCP677012	DVRS-012R	Right	12H	LCP677112	DVRS-012L	Left	12H

Specifications, size, shape subject to change without notice.
Picture shape if similar to any other manufacturers is just a co-incident.

29. Locking Plate Volar Column Distal Radius 2.4/2.7mm 9 Hole Head, Right/Left



Ref. No. Ti	Ref. No. SS	Position	Size
LCP666703	BK-003R	Right	3H
LCP666704	BK-004R	Right	4H
LCP666705	BK-005R	Right	5H

Ref. No. Ti	Ref. No. SS	Position	Size
LCP666603	BK-003L	Left	3H
LCP666604	BK-004L	Left	4H
LCP666605	BK-005L	Left	5H

8 Hole Head, Right/Left



Ref. No. Ti	Ref. No. SS	Position	Size
LCP666903	BL-003R	Right	3H
LCP666904	BL-004R	Right	4H
LCP666905	BL-005R	Right	5H

Ref. No. Ti	Ref. No. SS	Position	Size
LCP666803	BL-003L	Left	3H
LCP666804	BL-004L	Left	4H
LCP666805	BL-005L	Left	5H

31. Locking Plate Volar Column Distal Radius 2.4/2.7mm 6 Hole Head, Right/Left Fixed Angle



Ref. No. Ti	Ref. No. SS	Position	Size
LCP691602	VC-002R	Right	2H
LCP691603	VC-003R	Right	3H
LCP691604	VC-004R	Right	4H
LCP691605	VC-005R	Right	5H

Ref. No. Ti	Ref. No. SS	Position	Size
LCP691502	VC-002L	Left	2H
LCP691503	VC-003L	Left	3H
LCP691504	VC-004L	Left	4H
LCP691505	VC-005L	Left	5H



Ref. No. Ti	Ref. No. SS	Position	Size
LCPV691602	VAC-002R	Right	2H
LCPV691603	VAC-003R	Right	3H
LCPV691604	VAC-004R	Right	4H
LCPV691605	VAC-005R	Right	5H

Ref. No. Ti	Ref. No. SS	Position	Size
LCPV691502	VAC-002L	Left	2H
LCPV691503	VAC-003L	Left	3H
LCPV691504	VAC-004L	Left	4H
LCPV691505	VAC-005L	Left	5H

30. Locking Plate Proximal Radius 2.4/2.7mm Locking Rim Plate For Radial Head, Right/Left

Ref. No. Ti	Ref. No. SS	Position	Size
LCP720102	RHP-002R	Right	2H
LCP720103	RHP-003R	Right	3H
LCP720104	RHP-004R	Right	4H

Ref. No. Ti	Ref. No. SS	Position	Size
LCP720202	RHP-002L	Left	2H
LCP720203	RHP-003L	Left	3H
LCP720204	RHP-004L	Left	4H



Locking Neck Plate For Radial Head

Ref. No. Ti	Ref. No. SS	Size
LCP730002	NHP-002	2H
LCP730003	NHP-003	3H
LCP730004	NHP-004	4H

32. Locking Plate Extra-Articular Volar Distal Radius 2.4/2.7mm 4 Hole Head, Right/Left



FDA
510K
CLEARED

Ref. No. Ti	Ref. No. SS	Position	Size
LCP676103	VA-003R	Right	3H
LCP676104	VA-004R	Right	4H
LCP676105	VA-005R	Right	5H

Ref. No. Ti	Ref. No. SS	Position	Size
LCP676203	VA-003L	Left	3H
LCP676204	VA-004L	Left	4H
LCP676205	VA-005L	Left	5H



33. Locking Plate Extra-Articular Volar Distal Radius 2.4/2.7mm 5 Hole Head Type - I, Right/Left



Ref. No. Ti	Ref. No. SS	Position	Size	Ref. No. Ti	Ref. No. SS	Position	Size
LCP676303	VD-003R	Right	3H	LCP676403	VD-003L	Left	3H
LCP676304	VD-004R	Right	4H	LCP676404	VD-004L	Left	4H
LCP676305	VD-005R	Right	5H	LCP676405	VD-005L	Left	5H

35. Locking Plate Extra-Articular Volar Distal Radius 2.4/2.7mm 5 Hole Head Type - III, Right/Left



Ref. No. Ti	Ref. No. SS	Position	Size	Ref. No. Ti	Ref. No. SS	Position	Size
LCP676703	VS-003L	Right	3H	LCP676803	VS-003R	Left	3H
LCP676704	VS-004L	Right	4H	LCP676804	VS-004R	Left	4H
LCP676705	VS-005L	Right	5H	LCP676805	VS-005R	Left	5H

34. Locking Plate Extra-Articular Volar Distal Radius 2.4/2.7mm 5 Hole Head Type - II, Right/Left



Ref. No. Ti	Ref. No. SS	Position	Size	Ref. No. Ti	Ref. No. SS	Position	Size
LCP676503	VR-003R	Right	3H	LCP676603	VR-003L	Left	3H
LCP676504	VR-004R	Right	4H	LCP676604	VR-004L	Left	4H
LCP676505	VR-005R	Right	5H	LCP676605	VR-005L	Left	5H

36. Locking Plate Wrist Fusion

Standard Bend

Ref. No. Ti	Ref. No. SS
LCP667001	BM-000

Short Bend

Ref. No. Ti	Ref. No. SS
LCP667002	BN-000

Straight Bend

Ref. No. Ti	Ref. No. SS
LCP667003	BO-000



Specifications, size, shape subject to change without notice.
Picture shape if similar to any other manufacturers is just a co-incident.

37. Locking Plate Distal Lateral Radius 2.7mm



Ref. No. Ti	Ref. No. SS	Size
LCP556005	DLR-6005	5H
LCP556006	DLR-6006	6H

39. Locking Distal Dorsal Radius L-Plate 2.7mm, Right/Left



Ref. No. Ti	Ref. No. SS	Position	Size	Ref. No. Ti	Ref. No. SS	Position	Size
LCP556103	DDR-6103	Right	3H	LCP556203	DDR-6203	Left	3H
LCP556104	DDR-6104	Right	4H	LCP556204	DDR-6204	Left	4H

38. Locking Distal Dorsal Radius T-Plate 2.7mm



FDA
510K
CLEARED

Ref. No. Ti	Ref. No. SS	Size
LCP557003	DDR-7003	3H
LCP557004	DDR-7004	4H

40. Locking Distal Dorsal Radius L-Plate 2.7mm Type - II, Right/Left



Ref. No. Ti	Ref. No. SS	Position	Size	Ref. No. Ti	Ref. No. SS	Position	Size
LCP558103	DDR-8103	Right	3H	LCP558203	DDR-8203	Left	3H
LCP558104	DDR-8104	Right	4H	LCP558204	DDR-8204	Left	4H

Specifications, size, shape subject to change without notice.
Picture shape if similar to any other manufacturers is just a co-incident.



41. Locking Plate Radio Distal Dorsal 3.5mm, Right/Left



Ref. No. Ti	Ref. No. SS	Position	Size	Ref. No. Ti	Ref. No. SS	Position	Size
LCP503103	AG-003R	Right	3H	LCP503203	AG-003L	Left	3H
LCP503104	AG-004R	Right	4H	LCP503204	AG-004L	Left	4H
LCP503106	AG-006R	Right	6H	LCP503206	AG-006L	Left	6H
LCP503108	AG-008R	Right	8H	LCP503208	AG-008L	Left	8H
LCP503110	AG-010R	Right	10H	LCP503210	AG-010L	Left	10H

43. Locking Plate Reconstruction 3.5mm



Ref. No. Ti	Ref. No. SS	Size
LCP504003	EE-003	3H
LCP504004	EE-004	4H
LCP504005	EE-005	5H
LCP504006	EE-006	6H
LCP504007	EE-007	7H
LCP504008	EE-008	8H
LCP504009	EE-009	9H

Ref. No. Ti	Ref. No. SS	Size
LCP504010	EE-010	10H
LCP504011	EE-011	11H
LCP504012	EE-012	12H
LCP504013	EE-013	13H
LCP504014	EE-014	14H
LCP504015	EE-015	15H
LCP504016	EE-016	16H

42. Locking Plate Radio Distal Lateral 3.5mm



Ref. No. Ti	Ref. No. SS	Size
LCP502005	AF-005	5H
LCP502006	AF-006	6H

44. Locking Plate Reconstruction 4.5mm



Ref. No. Ti	Ref. No. SS	Size
LCP555003	AP-003	3H
LCP555004	AP-004	4H
LCP555005	AP-005	5H
LCP555006	AP-006	6H
LCP555007	AP-007	7H
LCP555008	AP-008	8H
LCP555009	AP-009	9H

Ref. No. Ti	Ref. No. SS	Size
LCP555010	AP-010	10H
LCP555011	AP-011	11H
LCP555012	AP-012	12H
LCP555013	AP-013	13H
LCP555014	AP-014	14H
LCP555015	AP-015	15H
LCP555016	AP-016	16H

Specifications, size, shape subject to change without notice.
Picture shape if similar to any other manufacturers is just a co-incident.

45. Locking Plate Proximal Femoral Lateral 4.5/5.0mm Type - I, Right/Left



FDA
510K
CLEARED

Ref. No. Ti	Ref. No. SS	Position	Size	Ref. No. Ti	Ref. No. SS	Position	Size
LCP531105	AO-005R	Right	5H	LCP531205	AO-005L	Left	5H
LCP531107	AO-007R	Right	7H	LCP531207	AO-007L	Left	7H
LCP531109	AO-009R	Right	9H	LCP531209	AO-009L	Left	9H
LCP531111	AO-011R	Right	11H	LCP531211	AO-011L	Left	11H
LCP531113	AO-013R	Right	13H	LCP531213	AO-013L	Left	13H

47. Locking Plate Pediatric Hip 3.5 & 5.0mm



Locking Plate Pediatric Hip 3.5mm

Ref. No. Ti	Ref. No. SS	Degree	Length
LCP6673100	BP-100-75	100°	75mm
LCP6673110	BP-110-75	110°	75mm
LCP6673120	BP-120-75	120°	75mm
LCP6673140	BP-140-70	140°	70mm
LCP6673150	BP-150-60	150°	60mm

Locking Plate Pediatric Hip 5.0mm

Ref. No. Ti	Ref. No. SS	Degree	Length
LCP6674100	BP-100-90	100°	90mm
LCP6674110	BP-110-90	110°	90mm
LCP6674120	BP-120-95	120°	95mm
LCP6674140	BP-140-90	140°	90mm
LCP6674150	BP-150-75	150°	75mm

46. Locking Plate Proximal Femoral Hook 4.5/5.0mm Type - II, Right/Left



Ref. No. Ti	Ref. No. SS	Position	Size	Ref. No. Ti	Ref. No. SS	POSITION	Size
LCP667102	BZ-002R	Right	2H	LCP667202	BZ-002L	Left	2H
LCP667104	BZ-004R	Right	4H	LCP667204	BZ-004L	Left	4H
LCP667106	BZ-006R	Right	6H	LCP667206	BZ-006L	Left	6H
LCP667108	BZ-008R	Right	8H	LCP667208	BZ-008L	Left	8H
LCP667110	BZ-010R	Right	10H	LCP667210	BZ-010L	Left	10H
LCP667112	BZ-012R	Right	12H	LCP667212	BZ-012L	Left	12H

48. Locking Plate DHS 135° With Long Barrel 38mm



Ref. No. Ti	Ref. No. SS	Size
LCP410004	AB-004	4H
LCP410005	AB-005	5H
LCP410006	AB-006	6H
LCP410007	AB-007	7H
LCP410008	AB-008	8H
LCP410009	AB-009	9H
LCP410010	AB-010	10H
LCP410011	AB-011	11H
LCP410012	AB-012	12H
LCP410013	AB-013	13H

Also Available in
125°/130°/140°/145°
in Short & Long Barrel

Ref. No. Ti	Ref. No. SS	Size
LCP410014	AB-014	14H
LCP410015	AB-015	15H
LCP410016	AB-016	16H
LCP410017	AB-017	17H
LCP410018	AB-018	18H
LCP410019	AB-019	19H
LCP410020	AB-020	20H
LCP410021	AB-021	21H
LCP410022	AB-022	22H



49. Locking Plate DCS 95°

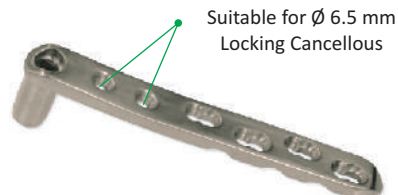

Ref. No. Ti	Ref. No. SS	Size
LCP510006	AC-006	6H
LCP510007	AC-007	7H
LCP510008	AC-008	8H
LCP510009	AC-009	9H
LCP510010	AC-010	10H
LCP510011	AC-011	11H
LCP510012	AC-012	12H
LCP510013	AC-013	13H
LCP510014	AC-014	14H

Ref. No. Ti	Ref. No. SS	Size
LCP510015	AC-015	15H
LCP510016	AC-016	16H
LCP510017	AC-017	17H
LCP510018	AC-018	18H
LCP510019	AC-019	19H
LCP510020	AC-020	20H
LCP510021	AC-021	21H
LCP510022	AC-022	22H

51. Locking Plate Narrow 4.5mm/5.0mm



Ref. No. Ti	Ref. No. SS	Size
LCP521004	II-004	4H
LCP521005	II-005	5H
LCP521006	II-006	6H
LCP521007	II-007	7H
LCP521008	II-008	8H
LCP521009	II-009	9H
LCP521010	II-010	10H

Ref. No. Ti	Ref. No. SS	Size
LCP521011	II-011	11H
LCP521012	II-012	12H
LCP521014	II-014	14H
LCP521016	II-016	16H
LCP521018	II-018	18H
LCP521020	II-020	20H
LCP521022	II-022	22H

50. Locking Plate Condylar Butteress 4.5/5.0mm, Right/Left



Ref. No. Ti	Ref. No. SS	Position	Size
LCP667506	CA-006R	Right	6H
LCP667508	CA-008R	Right	8H
LCP667510	CA-010R	Right	10H
LCP667512	CA-012R	Right	12H
LCP667514	CA-014R	Right	14H

Ref. No. Ti	Ref. No. SS	Position	Size
LCP667606	CA-006L	Left	6H
LCP667608	CA-008L	Left	8H
LCP667610	CA-010L	Left	10H
LCP667612	CA-012L	Left	12H
LCP667614	CA-014L	Left	14H

52. Locking Plate Curved Narrow 4.5mm/5.0mm



Ref. No. Ti	Ref. No. SS	Size
LCPC521010	II-010C	10H
LCPC521011	II-011C	11H
LCPC521012	II-012C	12H
LCPC521014	II-014C	14H
LCPC521016	II-016C	16H
LCPC521018	II-018C	18H
LCPC521020	II-020C	20H
LCPC521022	II-022C	22H

Specifications, size, shape subject to change without notice.
Picture shape if similar to any other manufacturers is just a co-incident.

53. Locking Plate Broad 4.5mm/5.0mm



FDA
510K
CLEARED

Ref. No. Ti	Ref. No. SS	SIZE
LCP522005	JJ-005	5H
LCP522006	JJ-006	6H
LCP522007	JJ-007	7H
LCP522008	JJ-008	8H
LCP522009	JJ-009	9H
LCP522010	JJ-010	10H
LCP522011	JJ-011	11H

Ref. No. Ti	Ref. No. SS	SIZE
LCP522012	JJ-012	12H
LCP522014	JJ-014	14H
LCP522016	JJ-016	16H
LCP522018	JJ-018	18H
LCP522020	JJ-020	20H
LCP522022	JJ-022	22H

55. Locking Plate Distal Femoral 4.5/5.0mm, Right/Left



FDA
510K
CLEARED

Ref. No. Ti	Ref. No. SS	Position	Size
LCP527105	KK-005	Right	5H
LCP527107	KK-007	Right	7H
LCP527109	KK-009	Right	9H
LCP527111	KK-011	Right	11H
LCP527113	KK-013	Right	13H

Ref. No. Ti	Ref. No. SS	Position	Size
LCP527205	LL-005	Left	5H
LCP527207	LL-007	Left	7H
LCP527209	LL-009	Left	9H
LCP527211	LL-011	Left	11H
LCP527213	LL-013	Left	13H

54. Locking Plate Curved Broad 4.5mm/5.0mm



FDA
510K
CLEARED

Ref. No. Ti	Ref. No. SS	Size
LCPCS22010	JJ-010C	10H
LCPCS22011	JJ-011C	11H
LCPCS22012	JJ-012C	12H
LCPCS22014	JJ-014C	14H
LCPCS22016	JJ-016C	16H
LCPCS22018	JJ-018C	18H
LCPCS22020	JJ-020C	20H
LCPCS22022	JJ-022C	22H
LCPCS22024	JJ-024C	24H
LCPCS22026	JJ-026C	26H

56. Locking Plate T-Fix Distal Femoral 4.5/5.0mm, Right/Left



Ref. No. Ti	Ref. No. SS	Position	Size
LCP531104	TFD-004R	Right	4H

Ref. No. Ti	Ref. No. SS	Position	Size
LCP531204	TFD-004L	Left	4H

Specifications, size, shape subject to change without notice.
Picture shape if similar to any other manufacturers is just a co-incident.



57. Locking Plate Periarticular Distal Femur 4.5/5.0mm Right/Left



Ref. No. Ti	Ref. No. SS	Position	Size	Ref. No. Ti	Ref. No. SS	Position	Size
LCP527306	PADF-006R	Right	6H	LCP527406	PADF-006L	Left	6H
LCP527308	PADF-008R	Right	8H	LCP527408	PADF-008L	Left	8H
LCP527310	PADF-010R	Right	10H	LCP527410	PADF-010L	Left	10H
LCP527312	PADF-012R	Right	12H	LCP527412	PADF-012L	Left	12H
LCP527314	PADF-014R	Right	14H	LCP527414	PADF-014L	Left	14H
LCP527316	PADF-016R	Right	16H	LCP527416	PADF-016L	Left	16H

59. Locking T-Plate Double Curved 4.5/5.0mm



Ref. No. Ti	Ref. No. SS	Size
LCP523003	VV-003	3H
LCP523004	VV-004	4H
LCP523005	VV-005	5H
LCP523006	VV-006	6H
LCP523007	VV-007	7H
LCP523008	VV-008	8H
LCP523010	VV-010	10H

58. Locking T-Plate Single Curved 4.5/5.0mm

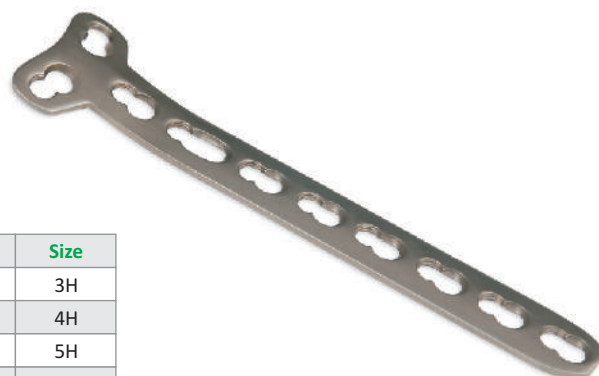

Ref. No. Ti	Ref. No. SS	Size
LCP524003	UU-003	3H
LCP524004	UU-004	4H
LCP524005	UU-005	5H
LCP524006	UU-006	6H
LCP524007	UU-007	7H
LCP524008	UU-008	8H
LCP524010	UU-010	10H

60. Locking T-Fix T-Plate 4.5/5.0mm

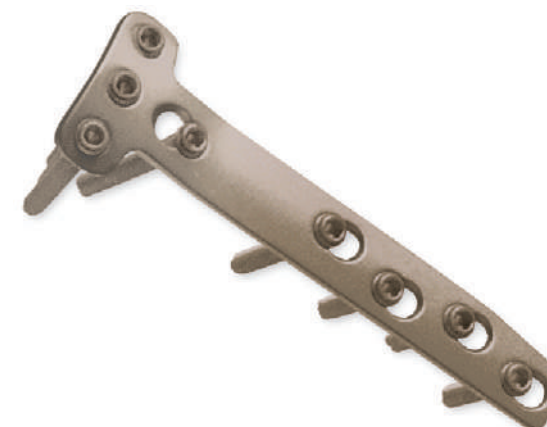

Ref. No. Ti	Ref. No. SS	Size
LCP537004	TFT-004	4H

Specifications, size, shape subject to change without notice.
Picture shape if similar to any other manufacturers is just a co-incident.

61. Locking L-Plate Double Curved 4.5/ 5.0mm, Right/Left



Ref. No. Ti	Ref. No. SS	Position	Size	Ref. No. Ti	Ref. No. SS	Position	Size
LCP525103	WX-003	Right	3H	LCP525203	WW-003	Left	3H
LCP525104	WX-004	Right	4H	LCP525204	WW-004	Left	4H
LCP525105	WX-005	Right	5H	LCP525205	WW-005	Left	5H
LCP525106	WX-006	Right	6H	LCP525206	WW-006	Left	6H
LCP525107	WX-007	Right	7H	LCP525207	WW-007	Left	7H
LCP525108	WX-008	Right	8H	LCP525208	WW-008	Left	8H

63. Locking Plate T-Fix Proximal Tibia 4.5/5.0mm, Right/Left



Ref. No. Ti	Ref. No. SS	Position	Size	Ref. No. Ti	Ref. No. SS	Position	Size
LCP530103	TFP-003R	Right	3H	LCP530203	TFP-003L	Left	3H

62. Locking Plate Proximal Lateral Tibia 4.5/5.0mm, Right/Left



FDA
510K
CLEARED

Ref. No. Ti	Ref. No. SS	Position	Size	Ref. No. Ti	Ref. No. SS	Position	Size
LCP526105	MM-005	Right	5H	LCP526205	NN-005	Left	5H
LCP526107	MM-007	Right	7H	LCP526207	NN-007	Left	7H
LCP526109	MM-009	Right	9H	LCP526209	NN-009	Left	9H
LCP526111	MM-011	Right	11H	LCP526211	NN-011	Left	11H
LCP526113	MM-013	Right	13H	LCP526213	NN-013	Left	13H

64. Locking Plate Proximal Tibia 3.5mm, Right/Left



FDA
510K
CLEARED

Ref. No. Ti	Ref. No. SS	Position	Size	Ref. No. Ti	Ref. No. SS	Position	Size
LCP667704	BQ-004R	Right	4H	LCP667804	BQ-004L	Left	4H
LCP667706	BQ-006R	Right	6H	LCP667806	BQ-006L	Left	6H
LCP667708	BQ-008R	Right	8H	LCP667808	BQ-008L	Left	8H
LCP667710	BQ-010R	Right	10H	LCP667810	BQ-010L	Left	10H
LCP667712	BQ-012R	Right	12H	LCP667812	BQ-012L	Left	12H
LCP667714	BQ-014R	Right	14H	LCP667814	BQ-014L	Left	14H
LCP667716	BQ-016R	Right	16H	LCP667816	BQ-016L	Left	16H

65. Locking Plate Proximal Lateral Tibia 4.5/5.0mm, Right/Left

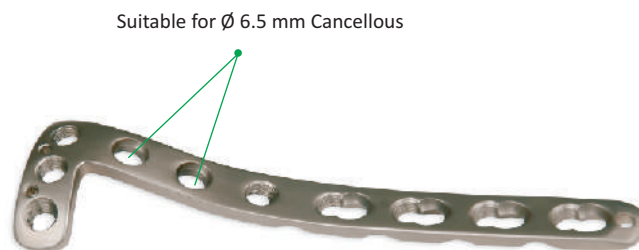

Ref. No. Ti	Ref. No. SS	Position	Size	Ref. No. Ti	Ref. No. SS	Position	Size
LCP667904	CB-004R	Right	4H	LCP668004	CB-004L	Left	4H
LCP667906	CB-006R	Right	6H	LCP668006	CB-006L	Left	6H
LCP667908	CB-008R	Right	8H	LCP668008	CB-008L	Left	8H
LCP667910	CB-010R	Right	10H	LCP668010	CB-010L	Left	10H
LCP667912	CB-012R	Right	12H	LCP668012	CB-012L	Left	12H

67. Locking Proximal Tibia Plate 3.5mm Type - II Low Bend, Right/Left



Ref. No. Ti	Ref. No. SS	Position	Size	Ref. No. Ti	Ref. No. SS	Position	Size
LCP681304	DD-004R	Right	4H	LCP681404	DD-004L	Left	4H
LCP681306	DD-006R	Right	6H	LCP681406	DD-006L	Left	6H
LCP681308	DD-008R	Right	8H	LCP681408	DD-008L	Left	8H
LCP681310	DD-010R	Right	10H	LCP681410	DD-010L	Left	10H
LCP681312	DD-012R	Right	12H	LCP681412	DD-012L	Left	12H
LCP681314	DD-014R	Right	14H	LCP681414	DD-014L	Left	14H

66. Locking Plate Medial Proximal Tibia 3.5mm, Right/Left



Ref. No. Ti	Ref. No. SS	Position	Size	Ref. No. Ti	Ref. No. SS	Position	Size
LCP881004	BR-004R	Right	4H	LCP880104	BR-004L	Left	4H
LCP881006	BR-006R	Right	6H	LCP880106	BR-006L	Left	6H
LCP881008	BR-008R	Right	8H	LCP880108	BR-008L	Left	8H
LCP881010	BR-010R	Right	10H	LCP880110	BR-010L	Left	10H
LCP881012	BR-012R	Right	12H	LCP880112	BR-012L	Left	12H
LCP881014	BR-014R	Right	14H	LCP880114	BR-014L	Left	14H

68. Locking Plate Periarticular Proximal Tibia 3.5mm, Right/Left



Ref. No. Ti	Ref. No. SS	Position	Size	Ref. No. Ti	Ref. No. SS	Position	Size
LCP691104	PAPT-3504R	Right	4H	LCP691204	PAPT-3504L	Left	4H
LCP691105	PAPT-3505R	Right	5H	LCP691205	PAPT-3505L	Left	5H
LCP691106	PAPT-3506R	Right	6H	LCP691206	PAPT-3506L	Left	6H
LCP691107	PAPT-3507R	Right	7H	LCP691207	PAPT-3507L	Left	7H
LCP691108	PAPT-3508R	Right	8H	LCP691208	PAPT-3508L	Left	8H
LCP691109	PAPT-3509R	Right	9H	LCP691209	PAPT-3509L	Left	9H
LCP691110	PAPT-3510R	Right	10H	LCP691210	PAPT-3510L	Left	10H
LCP691111	PAPT-3511R	Right	11H	LCP691211	PAPT-3511L	Left	11H
LCP691112	PAPT-3512R	Right	12H	LCP691212	PAPT-3512L	Left	12H
LCP691113	PAPT-3513R	Right	13H	LCP691213	PAPT-3513L	Left	13H
LCP691114	PAPT-3514R	Right	14H	LCP691214	PAPT-3514L	Left	14H

Specifications, size, shape subject to change without notice.
Picture shape if similar to any other manufacturers is just a co-incident.

69. Locking Plate Periarticular Proximal Tibia 3.5/5.0mm, Right/Left

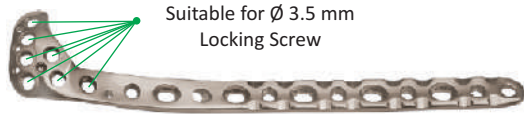

Ref. No. Ti	Ref. No. SS	Position	Size	Ref. No. Ti	Ref. No. SS	Position	Size
LCP691304	PAPT-5004R	Right	4H	LCP691404	PAPT-5004L	Left	4H
LCP691305	PAPT-5005R	Right	5H	LCP691405	PAPT-5005L	Left	5H
LCP691306	PAPT-5006R	Right	6H	LCP691406	PAPT-5006L	Left	6H
LCP691307	PAPT-5007R	Right	7H	LCP691407	PAPT-5007L	Left	7H
LCP691308	PAPT-5008R	Right	8H	LCP691408	PAPT-5008L	Left	8H
LCP691309	PAPT-5009R	Right	9H	LCP691409	PAPT-5009L	Left	9H
LCP691310	PAPT-5010R	Right	10H	LCP691410	PAPT-5010L	Left	10H
LCP691311	PAPT-5011R	Right	11H	LCP691411	PAPT-5011L	Left	11H
LCP691312	PAPT-5012R	Right	12H	LCP691412	PAPT-5012L	Left	12H
LCP691313	PAPT-5013R	Right	13H	LCP691413	PAPT-5013L	Left	13H
LCP691314	PAPT-5014R	Right	14H	LCP691414	PAPT-5014L	Left	14H

71. Locking Plate Medial Distal Tibia Without Tab 3.5mm, Right/Left



Ref. No. Ti	Ref. No. SS	Position	Size	Ref. No. Ti	Ref. No. SS	Position	Size
LCP668604	BX-004R	Right	4H	LCP668704	BX-004L	Left	4H
LCP668606	BX-006R	Right	6H	LCP668706	BX-006L	Left	6H
LCP668608	BX-008R	Right	8H	LCP668708	BX-008L	Left	8H
LCP668610	BX-010R	Right	10H	LCP668710	BX-010L	Left	10H
LCP668612	BX-012R	Right	12H	LCP668712	BX-012L	Left	12H

70. Locking Posteromedial Proximal Tibia Plate 3.5mm



Ref. No. Ti	Ref. No. SS	Size
LCP680001	PPTP-001	1H
LCP680002	PPTP-002	2H
LCP680004	PPTP-004	4H
LCP680006	PPTP-006	6H
LCP680008	PPTP-008	8H
LCP680010	PPTP-010	10H

72. Locking Plate Medial Proximal Tibia 4.5mm, Right/Left



Ref. No. Ti	Ref. No. SS	Position	Size	Ref. No. Ti	Ref. No. SS	Position	Size
LCP681704	MPT-004R	Right	4H	LCP681804	MPT-004L	Left	4H
LCP681706	MPT-006R	Right	6H	LCP681806	MPT-006L	Left	6H
LCP681708	MPT-008R	Right	8H	LCP681808	MPT-008L	Left	8H
LCP681710	MPT-010R	Right	10H	LCP681810	MPT-010L	Left	10H
LCP681712	MPT-012R	Right	12H	LCP681812	MPT-012L	Left	12H

Specifications, size, shape subject to change without notice.
Picture shape if similar to any other manufacturers is just a co-incident.



73. Locking Plate Anatomical Proximal Tibia 3.5mm, Right/Left



Ref. No. Ti	Ref. No. SS	Position	Size	Ref. No. Ti	Ref. No. SS	Position	Size
LCP677705	APT-005R	Right	5H	LCP677805	APT-005L	Left	5H
LCP677707	APT-007R	Right	7H	LCP677807	APT-007L	Left	7H
LCP677709	APT-009R	Right	9H	LCP677809	APT-009L	Left	9H
LCP677711	APT-011R	Right	11H	LCP677811	APT-011L	Left	11H
LCP677713	APT-013R	Right	13H	LCP677813	APT-013L	Left	13H

74. Locking Plate Anatomical Proximal Tibia 4.5/5.0mm, Right/Left



Ref. No. Ti	Ref. No. SS	Position	Size	Ref. No. Ti	Ref. No. SS	Position	Size
LCP687105	AR-005R	Right	5H	LCP687205	AR-005L	Left	5H
LCP687107	AR-007R	Right	7H	LCP687207	AR-007L	Left	7H
LCP687109	AR-009R	Right	9H	LCP687209	AR-009L	Left	9H
LCP687111	AR-011R	Right	11H	LCP687211	AR-011L	Left	11H
LCP687113	AR-013R	Right	13H	LCP687213	AR-013L	Left	13H

75. Locking Plate Distal Tibia 2.7/3.5mm, Right/Left

Suitable for \varnothing 2.7 mm
Locking Screw



Ref. No. Ti	Ref. No. SS	Position	Size	Ref. No. Ti	Ref. No. SS	Position	Size
LCP528404	BG-004R	Right	4H	LCP528304	BG-004L	Left	4H
LCP528406	BG-006R	Right	6H	LCP528306	BG-006L	Left	6H
LCP528408	BG-008R	Right	8H	LCP528308	BG-008L	Left	8H
LCP528410	BG-010R	Right	10H	LCP528310	BG-010L	Left	10H
LCP528412	BG-012R	Right	12H	LCP528312	BG-012L	Left	12H

76. Locking Plate Distal Tibia 3.5mm, Right/Left



Ref. No. Ti	Ref. No. SS	Position	Size	Ref. No. Ti	Ref. No. SS	Position	Size
LCP528104	AN-004R	Right	4H	LCP528204	AN-004L	Left	4H
LCP528106	AN-006R	Right	6H	LCP528206	AN-006L	Left	6H
LCP528108	AN-008R	Right	8H	LCP528208	AN-008L	Left	8H
LCP528110	AN-010R	Right	10H	LCP528210	AN-010L	Left	10H
LCP528112	AN-012R	Right	12H	LCP528212	AN-012L	Left	12H

Specifications, size, shape subject to change without notice.
Picture shape if similar to any other manufacturers is just a co-incident.

77. Locking Plate Metaphyseal 3.5/4.5/5.0mm

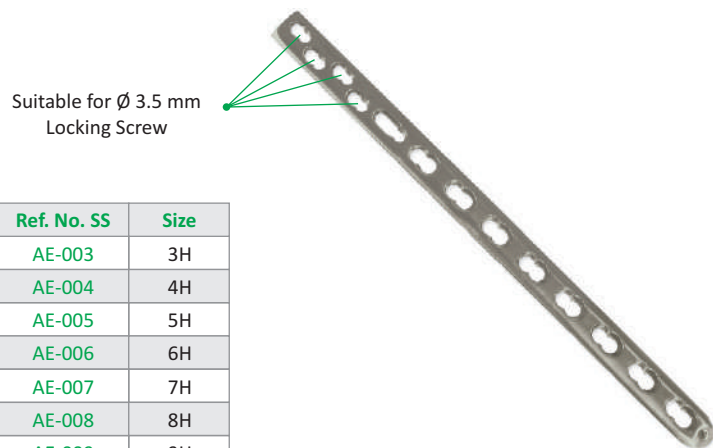

Ref. No. Ti	Ref. No. SS	Size
LCP507003	AE-003	3H
LCP507004	AE-004	4H
LCP507005	AE-005	5H
LCP507006	AE-006	6H
LCP507007	AE-007	7H
LCP507008	AE-008	8H
LCP507009	AE-009	9H
LCP507011	AE-011	11H

79. Locking Plate Anterolateral Distal Tibia 3.5mm, Right/Left



Ref. No. Ti	Ref. No. SS	Position	Size
LCP668405	BW-005R	Right	5H
LCP668407	BW-007R	Right	7H
LCP668409	BW-009R	Right	9H
LCP668411	BW-011R	Right	11H
LCP668413	BW-013R	Right	13H
LCP668415	BW-015R	Right	15H

Ref. No. Ti	Ref. No. SS	Position	Size
LCP668505	BW-005L	Left	5H
LCP668507	BW-007L	Left	7H
LCP668509	BW-009L	Left	9H
LCP668511	BW-011L	Left	11H
LCP668513	BW-013L	Left	13H
LCP668515	BW-015L	Left	15H

78. Locking Plate Metaphyseal For Distal Medial Tibia 3.5/4.5/5.0mm, Right/Left



Ref. No. Ti	Ref. No. SS	Position	Size
LCP678504	BY-004R	Right	4H
LCP678505	BY-005R	Right	5H
LCP678506	BY-006R	Right	6H
LCP678507	BY-007R	Right	7H
LCP678508	BY-008R	Right	8H
LCP678509	BY-009R	Right	9H
LCP678510	BY-010R	Right	10H
LCP678512	BY-012R	Right	12H
LCP678514	BY-014R	Right	14H

Ref. No. Ti	Ref. No. SS	Position	Size
LCP678604	BY-004L	Left	4H
LCP678605	BY-005L	Left	5H
LCP678606	BY-006L	Left	6H
LCP678607	BY-007L	Left	7H
LCP678608	BY-008L	Left	8H
LCP678609	BY-009L	Left	9H
LCP678610	BY-010L	Left	10H
LCP678612	BY-012L	Left	12H
LCP678614	BY-014L	Left	14H

80. Locking Plate Tibia Distal Lateral 4.5/5.0mm, Right/Left



Ref. No. Ti	Ref. No. SS	Position	Size
LCP505102	TD-002R	Right	2H
LCP505104	TD-004R	Right	4H
LCP505106	TD-006R	Right	6H
LCP505108	TD-008R	Right	8H
LCP505110	TD-010R	Right	10H

Ref. No. Ti	Ref. No. SS	Position	Size
LCP505202	TD-002L	Left	2H
LCP505204	TD-004L	Left	4H
LCP505206	TD-006L	Left	6H
LCP505208	TD-008L	Left	8H
LCP505210	TD-010L	Left	10H



81. Locking Plate Anatomical Distal Tibia 3.5mm, Right/Left



Ref. No. Ti	Ref. No. SS	Position	Size	Ref. No. Ti	Ref. No. SS	Position	Size
LCP677505	ADT-005R	Right	5H	LCP677605	ADT-005L	Left	5H
LCP677507	ADT-007R	Right	7H	LCP677607	ADT-007L	Left	7H
LCP677509	ADT-009R	Right	9H	LCP677609	ADT-009L	Left	9H
LCP677511	ADT-011R	Right	11H	LCP677611	ADT-011L	Left	11H
LCP677513	ADT-013R	Right	13H	LCP677613	ADT-013L	Left	13H

83. Locking Plate Pilon 3.5mm



Ref. No. Ti	Ref. No. SS	Size
LCP669007	BS-007	7H
LCP669009	BS-009	9H

82. Locking Plate Anatomical Distal Tibia 4.5/5.0mm, Right/Left



Ref. No. Ti	Ref. No. SS	Position	Size	Ref. No. Ti	Ref. No. SS	Position	Size
LCP678705	AQ-005R	Right	5H	LCP678805	AQ-005L	Left	5H
LCP678707	AQ-007R	Right	7H	LCP678807	AQ-007L	Left	7H
LCP678709	AQ-009R	Right	9H	LCP678809	AQ-009L	Left	9H
LCP678711	AQ-011R	Right	11H	LCP678811	AQ-011L	Left	11H
LCP678713	AQ-013R	Right	13H	LCP678813	AQ-013L	Left	13H

84. Locking Plate Fibula Distal Lateral 3.5mm



Ref. No. Ti	Ref. No. SS	Size
LCP235005	FD-005	5H
LCP235006	FD-006	6H
LCP235007	FD-007	7H
LCP235008	FD-008	8H
LCP235009	FD-009	9H
LCP235010	FD-010	10H
LCP235011	FD-011	11H
LCP235012	FD-012	12H
LCP235013	FD-013	13H
LCP235014	FD-014	14H

Specifications, size, shape subject to change without notice.
Picture shape if similar to any other manufacturers is just a co-incident.

85. Locking Plate Distal Fibula Lateral 2.7/3.5mm, Right/Left

Suitable for \varnothing 2.7mm
Locking Screw



Ref. No. Ti	Ref. No. SS	Position	Size	Ref. No. Ti	Ref. No. SS	Position	Size
LCP679603	LDFP-003R	Right	3H	LCP679503	LDFP-003L	Left	3H
LCP679604	LDFP-004R	Right	4H	LCP679504	LDFP-004L	Left	4H
LCP679605	LDFP-005R	Right	5H	LCP679505	LDFP-005L	Left	5H
LCP679606	LDFP-006R	Right	6H	LCP679506	LDFP-006L	Left	6H
LCP679607	LDFP-007R	Right	7H	LCP679507	LDFP-007L	Left	7H
LCP679609	LDFP-009R	Right	9H	LCP679509	LDFP-009L	Left	9H
LCP679611	LDFP-011R	Right	11H	LCP679511	LDFP-011L	Left	11H

87. Locking Plate Anatomical Distal Tibia Plate For Fibula 3.5mm, Right/Left



Ref. No. Ti	Ref. No. SS	Position	Size	Ref. No. Ti	Ref. No. SS	Position	Size
LCP679305	AT-005R	Right	5H	LCP679405	AT-005L	Left	5H
LCP679307	AT-007R	Right	7H	LCP679407	AT-007L	Left	7H
LCP679309	AT-009R	Right	9H	LCP679409	AT-009L	Left	9H
LCP679311	AT-011R	Right	11H	LCP679411	AT-011L	Left	11H
LCP679313	AT-013R	Right	13H	LCP679413	AT-013L	Left	13H

86. Locking Plate Posterolateral Distal Fibula Plate 2.7/3.5mm, Right/Left

Suitable for \varnothing 2.7mm
Locking Screw

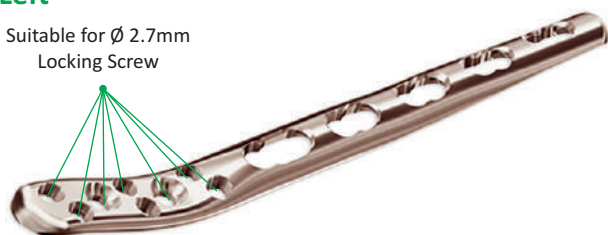

Ref. No. Ti	Ref. No. SS	Position	Size	Ref. No. Ti	Ref. No. SS	Position	Size
LCP679803	PDFP-003R	Right	3H	LCP679703	PDFP-003L	Left	3H
LCP679804	PDFP-004R	Right	4H	LCP679704	PDFP-004L	Left	4H
LCP679805	PDFP-005R	Right	5H	LCP679705	PDFP-005L	Left	5H
LCP679806	PDFP-006R	Right	6H	LCP679706	PDFP-006L	Left	6H
LCP679807	PDFP-007R	Right	7H	LCP679707	PDFP-007L	Left	7H
LCP679809	PDFP-009R	Right	9H	LCP679709	PDFP-009L	Left	9H
LCP679811	PDFP-011R	Right	11H	LCP679711	PDFP-011L	Left	11H

88. Locking Plate Anatomical Distal Tibia Plate For Fibula 4.5/5.0mm, Right/Left



Ref. No. Ti	Ref. No. SS	Position	Size	Ref. No. Ti	Ref. No. SS	Position	Size
LCP678305	ATF-005R	Right	5H	LCP678405	ATF-005L	Left	5H
LCP678307	ATF-007R	Right	7H	LCP678407	ATF-007L	Left	7H
LCP678309	ATF-009R	Right	9H	LCP678409	ATF-009L	Left	9H
LCP678311	ATF-011R	Right	11H	LCP678411	ATF-011L	Left	11H
LCP678313	ATF-013R	Right	13H	LCP678413	ATF-013L	Left	13H

Specifications, size, shape subject to change without notice.
Picture shape if similar to any other manufacturers is just a co-incident.



89. Locking Plate Calcaneal 3.5mm, Right/Left



Ref. No. Ti	Ref. No. SS	Position	Size
LCP860113	AX-013R	Right	13H
LCP860115	AX-015R	Right	15H

Ref. No. Ti	Ref. No. SS	Position	Size
LCP860013	AX-013L	Left	13H
LCP860015	AX-015L	Left	15H

91. Cortical Screw, Dia - 2.4mm - Self Tapping



Ref. No. Ti	Ref. No. SS	Length
701.06ST-Ti	701.06ST	06mm
701.08ST-Ti	701.08ST	08mm
701.10ST-Ti	701.10ST	10mm
701.12ST-Ti	701.12ST	12mm
701.14ST-Ti	701.14ST	14mm
701.16ST-Ti	701.16ST	16mm
701.18ST-Ti	701.18ST	18mm
701.20ST-Ti	701.20ST	20mm
701.22ST-Ti	701.22ST	22mm
701.24ST-Ti	701.24ST	24mm
701.26ST-Ti	701.26ST	26mm
701.28ST-Ti	701.28ST	28mm

Ref. No. Ti	Ref. No. SS	Length
701.30ST-Ti	701.30ST	30mm
701.32ST-Ti	701.32ST	32mm
701.34ST-Ti	701.34ST	34mm
701.36ST-Ti	701.36ST	36mm
701.38ST-Ti	701.38ST	38mm
701.40ST-Ti	701.40ST	40mm
701.42ST-Ti	701.42ST	42mm
701.44ST-Ti	701.44ST	44mm
701.46ST-Ti	701.46ST	46mm
701.48ST-Ti	701.48ST	48mm
701.50ST-Ti	701.50ST	50mm

90. DHS/DCS Lag Screw

Ref. No. Ti	Ref. No. SS	Length
LCP600060	ZZ-060	60mm
LCP600065	ZZ-065	65mm
LCP600070	ZZ-070	70mm
LCP600075	ZZ-075	75mm
LCP600080	ZZ-080	80mm
LCP600085	ZZ-085	85mm
LCP600090	ZZ-090	90mm
LCP600095	ZZ-095	95mm
LCP600100	ZZ-100	100mm
LCP600105	ZZ-105	105mm
LCP600110	ZZ-110	110mm
LCP600115	ZZ-115	115mm
LCP600120	ZZ-120	120mm



Compression Screw

Ref. No. Ti	Ref. No. SS	Length
LCP600000	ZZ-000	36mm

92. Cortical Screw, Dia - 2.7mm - Self Tapping



Ref. No. Ti	Ref. No. SS	Length
603.06ST-Ti	603.06ST	06mm
603.08ST-Ti	603.08ST	08mm
603.10ST-Ti	603.10ST	10mm
603.12ST-Ti	603.12ST	12mm
603.14ST-Ti	603.14ST	14mm
603.16ST-Ti	603.16ST	16mm
603.18ST-Ti	603.18ST	18mm
603.20ST-Ti	603.20ST	20mm
603.22ST-Ti	603.22ST	22mm
603.24ST-Ti	603.24ST	24mm
603.26ST-Ti	603.26ST	26mm
603.28ST-Ti	603.28ST	28mm

Ref. No. Ti	Ref. No. SS	Length
603.30ST-Ti	603.30ST	30mm
603.32ST-Ti	603.32ST	32mm
603.34ST-Ti	603.34ST	34mm
603.36ST-Ti	603.36ST	36mm
603.38ST-Ti	603.38ST	38mm
603.40ST-Ti	603.40ST	40mm
603.42ST-Ti	603.42ST	42mm
603.44ST-Ti	603.44ST	44mm
603.46ST-Ti	603.46ST	46mm
603.48ST-Ti	603.48ST	48mm
603.50ST-Ti	603.50ST	50mm

Specifications, size, shape subject to change without notice.
Picture shape if similar to any other manufacturers is just a co-incident.

93. Locking Head Screw, Dia - 2.7mm - Self Tapping



FDA
510K
CLEARED

Ref. No. Ti	Ref. No. SS	Length
LCP580006	DD-006	6mm
LCP580008	DD-008	8mm
LCP580010	DD-010	10mm
LCP580012	DD-012	12mm
LCP580014	DD-014	14mm
LCP580016	DD-016	16mm
LCP580018	DD-018	18mm
LCP580020	DD-020	20mm
LCP580022	DD-022	22mm

Ref. No. Ti	Ref. No. SS	Length
LCP580024	DD-024	24mm
LCP580026	DD-026	26mm
LCP580028	DD-028	28mm
LCP580030	DD-030	30mm
LCP580032	DD-032	32mm
LCP580034	DD-034	34mm
LCP580036	DD-036	36mm
LCP580038	DD-038	38mm
LCP580040	DD-040	40mm

95. Cortical Screw, Dia - 4.5mm - Self Tapping



FDA
510K
CLEARED

Ref. No. Ti	Ref. No. SS	Length
605.22ST-Ti	605.22ST	22mm
605.24ST-Ti	605.24ST	24mm
605.26ST-Ti	605.26ST	26mm
605.28ST-Ti	605.28ST	28mm
605.30ST-Ti	605.30ST	30mm
605.32ST-Ti	605.32ST	32mm
605.34ST-Ti	605.34ST	34mm
605.36ST-Ti	605.36ST	36mm
605.38ST-Ti	605.38ST	38mm
605.40ST-Ti	605.40ST	40mm
605.42ST-Ti	605.42ST	42mm
605.44ST-Ti	605.44ST	44mm
605.46ST-Ti	605.46ST	46mm

Ref. No. Ti	Ref. No. SS	Length
605.48ST-Ti	605.48ST	48mm
605.50ST-Ti	605.50ST	50mm
605.52ST-Ti	605.52ST	52mm
605.54ST-Ti	605.54ST	54mm
605.56ST-Ti	605.56ST	56mm
605.58ST-Ti	605.58ST	58mm
605.60ST-Ti	605.60ST	60mm
605.62ST-Ti	605.62ST	62mm
605.64ST-Ti	605.64ST	64mm
605.66ST-Ti	605.66ST	66mm
605.68ST-Ti	605.68ST	68mm
605.70ST-Ti	605.70ST	70mm

94. Cortical Screw, Dia - 3.5mm - Self Tapping



FDA
510K
CLEARED

Ref. No. Ti	Ref. No. SS	Length
604.14ST-Ti	604.14ST	14mm
604.16ST-Ti	604.16ST	16mm
604.18ST-Ti	604.18ST	18mm
604.20ST-Ti	604.20ST	20mm
604.22ST-Ti	604.22ST	22mm
604.24ST-Ti	604.24ST	24mm
604.26ST-Ti	604.26ST	26mm
604.28ST-Ti	604.28ST	28mm

Ref. No. Ti	Ref. No. SS	Length
604.30ST-Ti	604.30ST	30mm
604.32ST-Ti	604.32ST	32mm
604.34ST-Ti	604.34ST	34mm
604.36ST-Ti	604.36ST	36mm
604.38ST-Ti	604.38ST	38mm
604.40ST-Ti	604.40ST	40mm
604.45ST-Ti	604.45ST	45mm
604.50ST-Ti	604.50ST	50mm

96. Locking Head Screw, Dia - 3.5mm - Self Tapping



FDA
510K
CLEARED

Ref. No. Ti	Ref. No. SS	Length
LCP451010	OO-010	10mm
LCP451012	OO-012	12mm
LCP451014	OO-014	14mm
LCP451016	OO-016	16mm
LCP451018	OO-018	18mm
LCP451020	OO-020	20mm
LCP451022	OO-022	22mm
LCP451024	OO-024	24mm
LCP451026	OO-026	26mm
LCP451028	OO-028	28mm
LCP451030	OO-030	30mm
LCP451032	OO-032	32mm

Ref. No. Ti	Ref. No. SS	Length
LCP451034	OO-034	34mm
LCP451036	OO-036	36mm
LCP451038	OO-038	38mm
LCP451040	OO-040	40mm
LCP451045	OO-045	45mm
LCP451050	OO-050	50mm
LCP451055	OO-055	55mm
LCP451060	OO-060	60mm
LCP451065	OO-065	65mm
LCP451070	OO-070	70mm
LCP451075	OO-075	75mm
LCP451080	OO-080	80mm

Specifications, size, shape subject to change without notice.
Picture shape if similar to any other manufacturers is just a co-incident.



97. Locking Head Screw, Dia - 5.0mm - Self Tapping



Ref. No. Ti	Ref. No. SS	Length
LCP552014	PP-014	14mm
LCP552016	PP-016	16mm
LCP552018	PP-018	18mm
LCP552020	PP-020	20mm
LCP552022	PP-022	22mm
LCP552024	PP-024	24mm
LCP552026	PP-026	26mm
LCP552028	PP-028	28mm
LCP552030	PP-030	30mm
LCP552032	PP-032	32mm
LCP552034	PP-034	34mm
LCP552036	PP-036	36mm
LCP552038	PP-038	38mm
LCP552040	PP-040	40mm



Ref. No. Ti	Ref. No. SS	Length
LCP552042	PP-042	42mm
LCP552044	PP-044	44mm
LCP552046	PP-046	46mm
LCP552048	PP-048	48mm
LCP552050	PP-050	50mm
LCP552055	PP-055	55mm
LCP552060	PP-060	60mm
LCP552065	PP-065	65mm
LCP552070	PP-070	70mm
LCP552075	PP-075	75mm
LCP552080	PP-080	80mm
LCP552085	PP-085	85mm
LCP552090	PP-090	90mm

99. Locking Head Cancellous Screw Dia - 5.0mm "32mm Thread"

Ref. No. Ti	Ref. No. SS	Length
LCP503240	5032-40	40mm
LCP503245	5032-45	45mm
LCP503250	5032-50	50mm
LCP503255	5032-55	55mm
LCP503260	5032-60	60mm
LCP503265	5032-65	65mm
LCP503270	5032-70	70mm
LCP503275	5032-75	75mm
LCP503280	5032-80	80mm
LCP503285	5032-85	85mm
LCP503290	5032-90	90mm
LCP503295	5032-95	95mm
LCP5032100	5032-100	100mm
LCP5032105	5032-105	105mm
LCP5032110	5032-110	110mm



98. Locking Head Cancellous Screw Dia - 5.0mm "16mm Thread"

Ref. No. Ti	Ref. No. SS	Length
LCP501630	5016-30	30mm
LCP501635	5016-35	35mm
LCP501640	5016-40	40mm
LCP501645	5016-45	45mm
LCP501650	5016-50	50mm
LCP501655	5016-55	55mm
LCP501660	5016-60	60mm
LCP501665	5016-65	65mm
LCP501670	5016-70	70mm



Ref. No. Ti	Ref. No. SS	Length
LCP501675	5016-75	75mm
LCP501680	5016-80	80mm
LCP501685	5016-85	85mm
LCP501690	5016-90	90mm
LCP501695	5016-95	95mm
LCP5016100	5016-100	100mm
LCP5016105	5016-105	105mm
LCP5016110	5016-110	110mm

100. Locking Head Cancellous Screw Dia - 5.0mm "Full Thread"

Ref. No. Ti	Ref. No. SS	Length
LCP500025	5000-25	25mm
LCP500030	5000-30	30mm
LCP500035	5000-35	35mm
LCP500040	5000-40	40mm
LCP500045	5000-45	45mm
LCP500050	5000-50	50mm
LCP500055	5000-55	55mm
LCP500060	5000-60	60mm
LCP500065	5000-65	65mm



Ref. No. Ti	Ref. No. SS	Length
LCP500070	5000-70	70mm
LCP500075	5000-75	75mm
LCP500080	5000-80	80mm
LCP500085	5000-85	85mm
LCP500090	5000-90	90mm
LCP500095	5000-95	95mm
LCP500100	5000-100	100mm
LCP500105	5000-105	105mm
LCP500110	5000-110	110mm

Specifications, size, shape subject to change without notice.
Picture shape if similar to any other manufacturers is just a co-incident.

101. Locking Head Screw, Dia - 6.5mm "16mm Thread"



Ref. No. Ti	Ref. No. SS	Length
LCP651630	6516-30	30mm
LCP651635	6516-35	35mm
LCP651640	6516-40	40mm
LCP651645	6516-45	45mm
LCP651650	6516-50	50mm
LCP651655	6516-55	55mm
LCP651660	6516-60	60mm
LCP651665	6516-65	65mm
LCP651670	6516-70	70mm

Ref. No. Ti	Ref. No. SS	Length
LCP651675	6516-75	75mm
LCP651680	6516-80	80mm
LCP651685	6516-85	85mm
LCP651690	6516-90	90mm
LCP651695	6516-95	95mm
LCP6516100	6516-100	100mm
LCP6516105	6516-105	105mm
LCP6516110	6516-110	110mm

103. Locking Head Cancellous Screw Dia - 6.5mm "Full Thread"



Ref. No. Ti	Ref. No. SS	Length
LCP650025	6500-25	25mm
LCP650030	6500-30	30mm
LCP650035	6500-35	35mm
LCP650040	6500-40	40mm
LCP650045	6500-45	45mm
LCP650050	6500-50	50mm
LCP650055	6500-55	55mm
LCP650060	6500-60	60mm
LCP650065	6500-65	65mm

Ref. No. Ti	Ref. No. SS	Length
LCP650070	6500-70	70mm
LCP650075	6500-75	75mm
LCP650080	6500-80	80mm
LCP650085	6500-85	85mm
LCP650090	6500-90	90mm
LCP650095	6500-95	95mm
LCP650100	6500-100	100mm
LCP650105	6500-105	105mm
LCP650110	6500-110	110mm

102. Locking Head Cancellous Screw Dia - 6.5mm "32mm Thread"



Ref. No. Ti	Ref. No. SS	Length
LCP653240	6532-40	40mm
LCP653245	6532-45	45mm
LCP653250	6532-50	50mm
LCP653255	6532-55	55mm
LCP653260	6532-60	60mm
LCP653265	6532-65	65mm
LCP653270	6532-70	70mm
LCP653275	6532-75	75mm
LCP653280	6532-80	80mm
LCP653285	6532-85	85mm
LCP653290	6532-90	90mm
LCP653295	6532-95	95mm
LCP6532100	6532-100	100mm
LCP6532105	6532-105	105mm
LCP6532110	6532-110	110mm

104. Locking Head Cancellous Screw 3.5 mm "Full Thread"



Ref. No. Ti	Ref. No. SS	Length
LCP-35F-014	35F-014	14mm
LCP-35F-016	35F-016	16mm
LCP-35F-018	35F-018	18mm
LCP-35F-020	35F-020	20mm
LCP-35F-022	35F-022	22mm
LCP-35F-024	35F-024	24mm
LCP-35F-026	35F-026	26mm
LCP-35F-028	35F-028	28mm
LCP-35F-030	35F-030	30mm
LCP-35F-035	35F-035	35mm
LCP-35F-040	35F-040	40mm
LCP-35F-045	35F-045	45mm
LCP-35F-050	35F-050	50mm
LCP-35F-055	35F-055	55mm
LCP-35F-060	35F-060	60mm

Specifications, size, shape subject to change without notice.
Picture shape if similar to any other manufacturers is just a co-incident.



105. Locking Head Cancellous Screw 3.5 mm "Short Thread"

Ref. No. Ti	Ref. No. SS	Length
LCP-35S-014	35S-014	14mm
LCP-35S-016	35S-016	16mm
LCP-35S-018	35S-018	18mm
LCP-35S-020	35S-020	20mm
LCP-35S-022	35S-022	22mm
LCP-35S-024	35S-024	24mm
LCP-35S-026	35S-026	26mm
LCP-35S-028	35S-028	28mm
LCP-35S-030	35S-030	30mm
LCP-35S-035	35S-035	35mm
LCP-35S-040	35S-040	40mm
LCP-35S-045	35S-045	45mm
LCP-35S-050	35S-050	50mm
LCP-35S-055	35S-055	55mm
LCP-35S-060	35S-060	60mm



107. Locking Head Cannulated Cancellous Screw Dia - 5.0mm"32mm Thread"

Ref. No. Ti	Ref. No. SS	Length
LCP513240	5132-40	40mm
LCP513245	5132-45	45mm
LCP513250	5132-50	50mm
LCP513255	5132-55	55mm
LCP513260	5132-60	60mm
LCP513265	5132-65	65mm
LCP513270	5132-70	70mm
LCP513275	5132-75	75mm



Ref. No. Ti	Ref. No. SS	Length
LCP513280	5132-80	80mm
LCP513285	5132-85	85mm
LCP513290	5132-90	90mm
LCP513295	5132-95	95mm
LCP5132100	5132-100	100mm
LCP5132105	5132-105	105mm
LCP5132110	5132-110	110mm

106. Locking Head Cannulated Cancellous Screw Dia - 5.0mm "16mm Thread"

Ref. No. Ti	Ref. No. SS	Length
LCP511630	5116-30	30mm
LCP511635	5116-35	35mm
LCP511640	5116-40	40mm
LCP511645	5116-45	45mm
LCP511650	5116-50	50mm
LCP511655	5116-55	55mm
LCP511660	5116-60	60mm
LCP511665	5116-65	65mm
LCP511670	5116-70	70mm



Ref. No. Ti	Ref. No. SS	Length
LCP511675	5116-75	75mm
LCP511680	5116-80	80mm
LCP511685	5116-85	85mm
LCP511690	5116-90	90mm
LCP511695	5116-95	95mm
LCP5116100	5116-100	100mm
LCP5116105	5116-105	105mm
LCP5116110	5116-110	110mm

108. Locking Head Cannulated Cancellous Screw Dia - 5.0mm "Full Thread"

Ref. No. Ti	Ref. No. SS	Length
LCP510025	5100-25	25mm
LCP510030	5100-30	30mm
LCP510035	5100-35	35mm
LCP510040	5100-40	40mm
LCP510045	5100-45	45mm
LCP510050	5100-50	50mm
LCP510055	5100-55	55mm
LCP510060	5100-60	60mm
LCP510065	5100-65	65mm



Ref. No. Ti	Ref. No. SS	Length
LCP510070	5100-70	70mm
LCP510075	5100-75	75mm
LCP510080	5100-80	80mm
LCP510085	5100-85	85mm
LCP510090	5100-90	90mm
LCP510095	5100-95	95mm
LCP5100100	5100-100	100mm
LCP5100105	5100-105	105mm
LCP5100110	5100-110	110mm

Specifications, size, shape subject to change without notice.
Picture shape if similar to any other manufacturers is just a co-incident.

109 Locking Head Cannulated Cancellous Screw 3.5 mm "Full Thread"

Ref. No. Ti	Ref. No. SS	Length
LCCS-35F-014	LC683-14	14mm
LCCS-35F-016	LC683-16	16mm
LCCS-35F-018	LC683-18	18mm
LCCS-35F-020	LC683-20	20mm
LCCS-35F-022	LC683-22	22mm
LCCS-35F-024	LC683-24	24mm
LCCS-35F-026	LC683-26	26mm
LCCS-35F-028	LC683-28	28mm
LCCS-35F-030	LC683-30	30mm
LCCS-35F-035	LC683-35	35mm
LCCS-35F-040	LC683-40	40mm
LCCS-35F-045	LC683-45	45mm
LCCS-35F-050	LC683-50	50mm
LCCS-35F-055	LC683-55	55mm
LCCS-35F-060	LC683-60	60mm



111. Locking Head Cannulated Cancellous Screw Dia - 6.5mm "16mm Thread"

Ref. No. Ti	Ref. No. SS	Length
LCP661630	6116-30	30mm
LCP661635	6116-35	35mm
LCP661640	6116-40	40mm
LCP661645	6116-45	45mm
LCP661650	6116-50	50mm
LCP661655	6116-55	55mm
LCP661660	6116-60	60mm
LCP661665	6116-65	65mm
LCP661670	6116-70	70mm



Ref. No. Ti	Ref. No. SS	Length
LCP661675	6116-75	75mm
LCP661680	6116-80	80mm
LCP661685	6116-85	85mm
LCP661690	6116-90	90mm
LCP661695	6116-95	95mm
LCP6616100	6116-100	100mm
LCP6616105	6116-105	105mm
LCP6616110	6116-110	110mm

110. Locking Head Cannulated Cancellous Screw 3.5 mm "Short Thread"

Ref. No. Ti	Ref. No. SS	Length
LCCS-35S-014	LC684-14	14mm
LCCS-35S-016	LC684-16	16mm
LCCS-35S-018	LC684-18	18mm
LCCS-35S-020	LC684-20	20mm
LCCS-35S-022	LC684-22	22mm
LCCS-35S-024	LC684-24	24mm
LCCS-35S-026	LC684-26	26mm
LCCS-35S-028	LC684-28	28mm
LCCS-35S-030	LC684-30	30mm
LCCS-35S-035	LC684-35	35mm
LCCS-35S-040	LC684-40	40mm
LCCS-35S-045	LC684-45	45mm
LCCS-35S-050	LC684-50	50mm
LCCS-35S-055	LC684-55	55mm
LCCS-35S-060	LC684-60	60mm



112. Locking Head Cannulated Cancellous Screw Dia - 6.5mm "32mm Thread"

Ref. No. Ti	Ref. No. SS	Length
LCP663240	6132-40	40mm
LCP663245	6132-45	45mm
LCP663250	6132-50	50mm
LCP663255	6132-55	55mm
LCP663260	6132-60	60mm
LCP663265	6132-65	65mm
LCP663270	6132-70	70mm
LCP663275	6132-75	75mm



Ref. No. Ti	Ref. No. SS	Length
LCP663280	6132-80	80mm
LCP663285	6132-85	85mm
LCP663290	6132-90	90mm
LCP663295	6132-95	95mm
LCP6632100	6132-100	100mm
LCP6632105	6132-105	105mm
LCP6632110	6132-110	110mm

Specifications, size, shape subject to change without notice.
Picture shape if similar to any other manufacturers is just a co-incident.



113. Locking Head Cannulated Cancellous Screw Dia - 6.5mm "Full Thread"



Ref. No. Ti	Ref. No. SS	Length
LCP660025	6100-25	25mm
LCP660030	6100-30	30mm
LCP660035	6100-35	35mm
LCP660040	6100-40	40mm
LCP660045	6100-45	45mm
LCP660050	6100-50	50mm
LCP660055	6100-55	55mm
LCP660060	6100-60	60mm
LCP660065	6100-65	65mm

Ref. No. Ti	Ref. No. SS	Length
LCP660070	6100-70	70mm
LCP660075	6100-75	75mm
LCP660080	6100-80	80mm
LCP660085	6100-85	85mm
LCP660090	6100-90	90mm
LCP660095	6100-95	95mm
LCP660100	6100-100	100mm
LCP6600105	6100-105	105mm
LCP6600110	6100-110	110mm

115. Premium Quality - Special Instrument Set



Ref. No.	Description
10000.00	CARE Locking Instrument Set 2.7mm
11000.00	CARE Locking Instrument Set 3.5mm
12000.00	CARE Locking Instrument Set 4.5/5.0mm

114. Standard Quality - Special Instrument Set

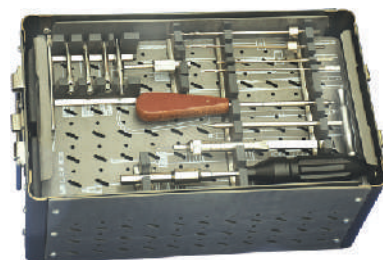

Ref. No.	Description
LC-2700	CARE Locking Instrument Set 2.7mm
LC-3500	CARE Locking Instrument Set 3.5mm
LC-4500	CARE Locking Instrument Set 4.5/5.0mm

116. Premium Quality - Complete Instrument Set

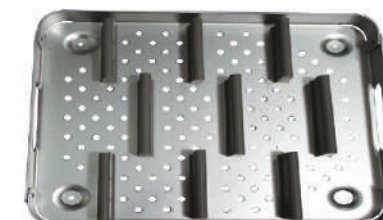

Ref. No.	Description
LCP.27..100	CARE Locking Instrument Set 2.7mm
LCP.35..200	CARE Locking Instrument Set 3.5mm
LCP.45..300	CARE Locking Instrument Set 4.5/5.0mm

Specifications, size, shape subject to change without notice.
Picture shape if similar to any other manufacturers is just a co-incident.

www.orthocare.in | www.orthoimplants.com



FROM WHEELS TO HEELS

ORTHO CARE

H.O.: 3/10 Kirti Nagar Industrial Area, New Delhi - 110015, INDIA

Phone : +91-11-41424511 | 41424522 | 45092044 **Fax :** +91-11-47510708

E-mail : impex@orthocare.in **Web :** www.orthocare.in | www.orthoimplants.com

Factory : A-31, Sector A-4, Tronica City Loni, Ghaziabad (U.P.) INDIA

USFDA 510K CLEARED PRODUCTS

CE 1023 CERTIFIED PRODUCTS

ISO 13485:2012 CERTIFICATION

INDIAN FDA LICENSE NO. 05/SC/P/2011

ORTHO CARE / 03/18/2000